

Laminex®

Waterloo™ Partitioning Systems

Partitions, Lockers, Vanities & Seating.



A proud
Australian
manufacturer

Laminex® Waterloo™ Partitioning Systems

Laminex Waterloo is made from high quality Australian Made Laminex substrates, backed by 85 years of expertise for quality you can trust. Assembled locally in Australia using only Global GreenTag certified Laminex substrates, the Laminex Waterloo range includes Shower and Toilet Partitions, Locker Systems, Vanities, Seating, Privacy Panels and Wall Panels. These can be customised for applications ranging from offices, retail spaces, health care facilities, educational facilities, sports and recreation venues and everywhere in between.

Why use Laminex Waterloo Partitioning Systems?



National Coverage

- National distribution coverage
- Nationwide approved referral installation network
- National sales & after sales support



Superior Quality

- Made from quality Laminex substrates with Global GreenTag certification
- Quality and durable system designs including:
 - Reinforced aluminium head rails for system strength
 - Anodised aluminium hardware & stainless steel screws
 - Rounded panel/door edges for added safety
- In-house design & manufacturing with total control of the process from start to finish.



Antimicrobial Surface Technology

- Laminex Multipurpose Compact Laminate & Laminex Structural MR® MDF features Protec+ Antimicrobial Technology, which inhibits the growth of bacteria, fungus, mould and now the COVID-19 virus.



Proud Australian Manufacturer

- Assembled in regional Australia
- Made from Australian made substrates.



Superior Warranties & Guarantees

- Laminex Compact Laminate Warranty - 10 years
- Laminex Structural MR® MDF Warranty - 7 years
- Partitioning Door Hardware Replacement Guarantee* - 5 years

FRONT COVER: Floor to Ceiling Arched Doors Partitioning System in Laminex AbsoluteMatte Multipurpose Compact in Otway with matte black hardware.

*Applies only to Partitioning Systems

Features & Benefits



Strong, robust hardware and fittings that complete the look

Our Waterloo range is supplied with a range of durable and high quality hardware for all of our systems.

Our Partitioning Systems are fitted with our exclusive 'Wave' hardware systems and stainless steel fittings for maximum reliability. We also use high quality reinforced aluminium headrails for added system strength.

And our Locker Systems use Europe's market leader, Ojmar locks, for our wide range of lock options.

Ease of installation

Laminex Waterloo Partitioning Systems are delivered cut-to-size and pre-drilled as 'flat packs,' complete with instructions and tools. In addition, our substrates are able to be cut on site if required.

This offer is available to all our account customers, but if you need someone to install our system for you, we have a nationwide approved referral installation network.

Sustainability

Laminex is committed to sustainability. It underpins all of our processes, from product manufacturing to building practices and forest management.

Our Laminex Waterloo range consists of two Global GreenTag rated substrates; Laminex Multipurpose Compact Laminate & Laminex Structural MR[®] MDF. Both are manufactured in wood sourced materials from sustainable, non-controversial plantations and achieve GreenRate Level A ratings.

Find all our documentation, certificates and reports at laminex.com.au.





Now more than ever, we understand the importance of maintaining hygiene in interior spaces we frequently touch such as toilet and shower partitioning.

Laminex has taken the lead with the introduction of Protec+, an antimicrobial surface technology that inhibits the growth of bacteria, fungus and now the COVID-19 virus, so whether you choose Multipurpose Compact Laminate or Structural MR MDF the surface will be protected.

Protec+ Fast Facts



Peace of mind

Laminex Protec+ antifungal and antibacterial properties do not wipe off or leach out of the surface. This gives you enhanced antimicrobial protection for the expected life of the surface.



Cleaner environments, everywhere

Laminex Protec+ can be used to create a safer, cleaner environment anywhere, including hospitals, schools, hotels, shops, cafes, sport facilities and public toilets.



Proved effectiveness

Laminex Protec+ has been independently tested in accordance with a number of leading standards, including: ISO22196:2011, JIS Z2801 and ASTM G21, which measure antimicrobial activity and fungi resistance.

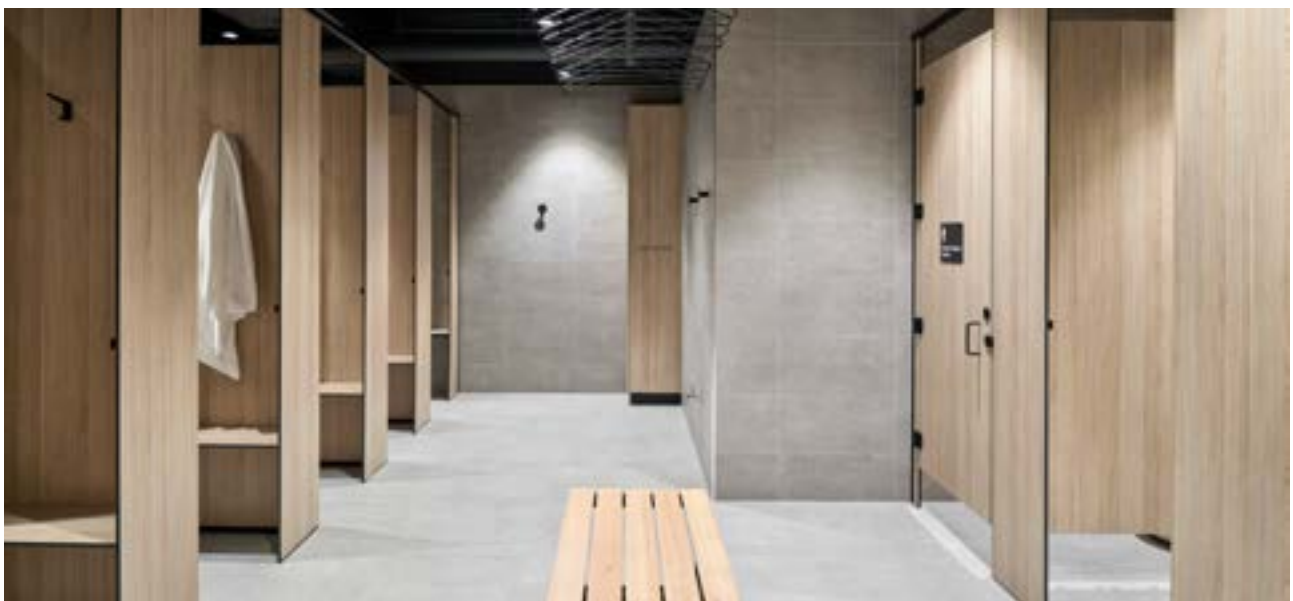

ABOVE: Toilet & Shower Partitioning: Floor to Ceiling Partitioning System in **Laminex Multipurpose Compact Laminate** in **Classic Oak**.
Project: Pinnacle One Gym. Architect/Designer: InOne Projects. Photographer: Martin Seigner (FRMEZ).

Designing your Laminex Waterloo System

Step 01

Choose Your System

Partitions, Lockers, Vanities, Seating



Step 02

Choose Your Substrate

Compact Laminate or Structural MR MDF



Step 03

Choose Your Colour & Finish



Step 01

Choose Your System



ABOVE: Toilet Partitioning: Floor to Ceiling Arched Doors Laminex AbsoluteMatte Multipurpose Compact Laminate in Otway.
Vanity Base: Laminex Multipurpose Compact Laminate in Planked Urban Oak. Vanity Top: Laminex Compact Laminate in Otway.

Navigating the range

With a range of different systems and products to choose from, there's a Laminex Waterloo system suitable for your next project.



Partitioning Systems

Discover Laminex Waterloo Partitioning Systems and learn how effortless toilet and shower partitioning can really be. Choose from our standard range of systems, or work with our expert design team on a custom solution.



Locker Systems

With a wide range of colours and systems to choose from, along with a range of hardware options, Laminex Waterloo can outfit your locker and storage needs to complete your fit out. Choose from 1, 2, 3, 4 or Z Door designs, or customise your design.



Seating Systems

Complete your fit out with our pre-fabricated or custom designed seating and combination units. Choose from island or wall seating systems with full or slat seat benches, or combine your seating and locker design by selecting a combination unit.



Vanities

Designed for style and strength, and available in a wide range of colours, complement the rest of your project with our range of versatile vanities.

Select basins & tapware from a wide range to suit your design and application.

Scan the code to explore the range.



Toilet & Shower Partitioning Systems

Available in a variety of functional designs, Laminex Waterloo Toilet & Shower Partitioning Systems are ideal for many applications, looks and budgets. Featuring our Protec+ anti-microbial technology, our impact resistant Multipurpose Compact Laminate and Structural MR MDF (dry areas only), and highest quality hardware are integrated into a design that offers exceptional durability and stability, is easy to clean and offers overall low maintenance.

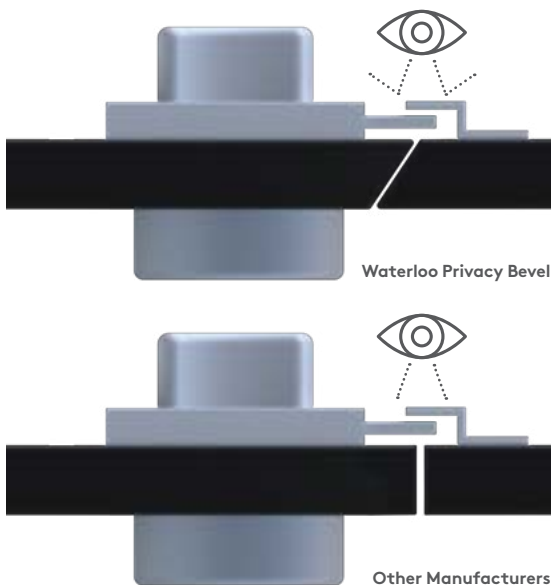

Privacy is Not An Optional Extra

Now available as a standard design across our Compact Laminate Partitioning range, our Privacy Bevel profiled doors allows for ultimate privacy without compromising design and aesthetics.

NB. Privacy bevel is only available for Multipurpose Compact Laminate, not available in Laminex Structural MR® MDF.



ABOVE: Floor to Ceiling Partitioning System in **Laminex Multipurpose Compact Laminate** in **Classic Oak**.
Project: Pinnacle One Gym. Architect/Designer: InOne Projects. Photographer: Martin Seigner (FRMEZ).

Hardware & Components

Each system is pre-drilled and supplied with a range of durable, anodised hardware. A hardware kit includes a minimum of 3 concealed gravity hinges per door for added strength, door coat hooks, door stops, single action slide locks, slimline headrails and height adjustable legs where applicable.

For maximum reliability, our hardware is not off the shelf generic hardware. Instead we have developed our own exclusive 'Wave' hardware and reinforced aluminium headrails, and to top it off, all hardware is supplied with stainless steel fixings. Matte Black Hardware and Powdercoating Hardware to match Laminex Decors or Dulux colours is available as an upgrade option.

For even greater peace of mind, all Laminex Waterloo Partitioning System hardware now comes with a 5 year Door Hardware Replacement Guarantee, which includes hardware failure, as well as vandalism and accidental breakage.

For full terms and conditions, including how to make a claim go to: [Laminex.com.au](https://www.laminex.com.au)



Coat Hook
Satin Chrome | Matte Black*



Slide Lock
Satin Chrome | Matte Black*

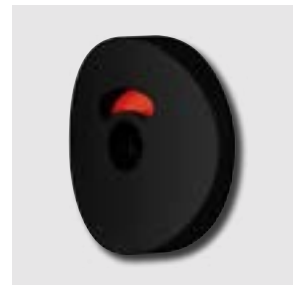

Lock Indicator
Satin Chrome | Matte Black*



Gravity Concealed Hinge
Satin Chrome | Matte Black*



Slimline Door Bumper
Satin Chrome | Matte Black*



Pedestal Mounted Feet
Satin Chrome | Matte Black*



Round Head Rail
Satin Chrome | Matte Black*







U Channel
Satin Chrome | Matte Black*

* Matte Black Hardware is an upgrade option

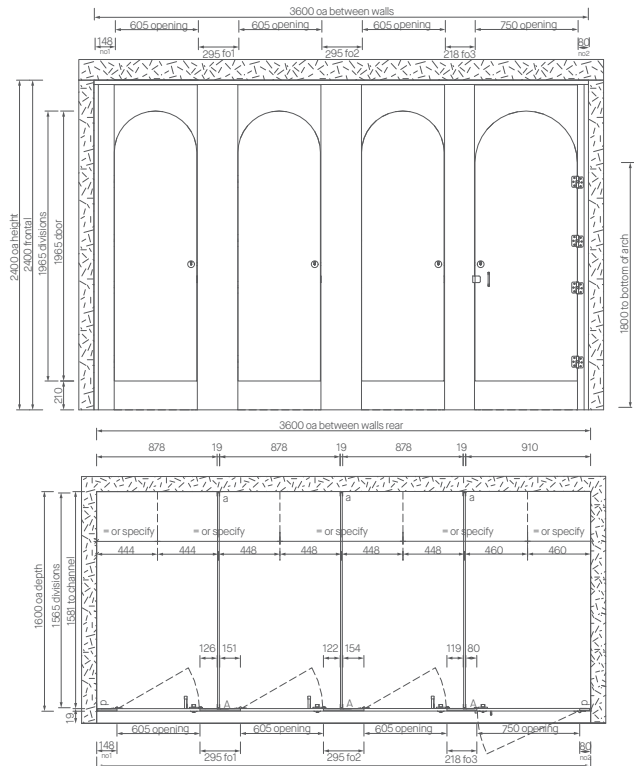
Floor to Ceiling System*

Available in a range of door options to suit your design preferences, this system is a sleek and modern solution for public washrooms and end-of-trip facilities. Select our square doors for a robust look, or upgrade to our generously arched doors for a contemporary and stylish touch.



Panel Substrate	Laminex Multipurpose Compact Laminate 13mm Laminex Multipurpose Compact Laminate 18mm (MTO)	  
Features	Anodised aluminium headrail Design registered lock/indicator Design registered concealed hinges and coat hook Available in square doors or upgrade to arched doors Privacy Bevel as standard ensures no visibility into the cubicle when in use	
Hardware	Stainless steel fixings U-shaped corner channels Snap door inserts	
Delivery and installation	Flat pack with instructions and tools for your own installation	
Warranty and Guarantees	Laminex Compact Laminate - 10 years Door Hardware Replacement Guarantee - 5 Years	
Recommended Applications	Ideal for High Traffic and High Wear Applications such as: <ul style="list-style-type: none"> - Education Amenities - Retail Amenities - Public Spaces Amenities - End of Trip Facilities 	

* Compact laminate is not designed for permanent immersion. Please ensure that installation conforms to the National Construction Code and water is not allowed to pool at the base of the partitioning.

Pedestal Mounted System

A functional and affordable system that is mounted off the floor with adjustable anodised aluminium legs, and is braced overhead.

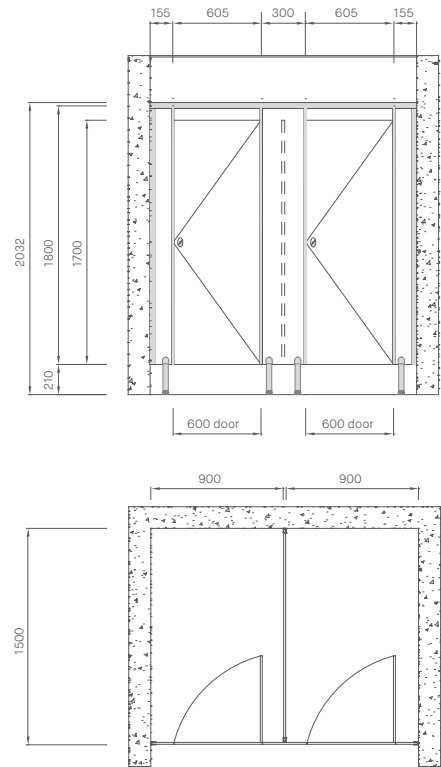

Panel Substrate	Laminex Structural MR® MDF 18mm Laminex Structural MR® MDF 32mm Laminex Multipurpose Compact Laminate 13mm Laminex Multipurpose Compact Laminate 18mm (MTO)
Features	Anodised aluminium headrail Design registered lock/indicator Design registered concealed hinges and coat hook Privacy Bevel as standard ensures no visibility into the cubicle when in use
Hardware	Concealed fixing anodised aluminium adjustable legs Stainless steel fixings Custom extrusion corner channels Snap door inserts Design registered Slimline Reinforced Headrail
Delivery and installation	Flat pack with instructions and tools for your own installation
Warranty & Guarantees	Laminex Structural MR® MDF - 7 years Laminex Compact Laminate - 10 years Door Hardware Replacement Guarantee - 5 Years
Recommended Applications	Ideal for High Traffic and High Wear Applications such as: - Education Amenities - Retail Amenities - Public Spaces Amenities



Doors in **Laminex Multipurpose Compact Laminate in Oyster Linea**.
Panels in **Laminex Multipurpose Compact Laminate in Battalion**.

Floor Mounted System*

All about the look, this system has floor mounted front panels with no visible fixings, and is braced overhead.

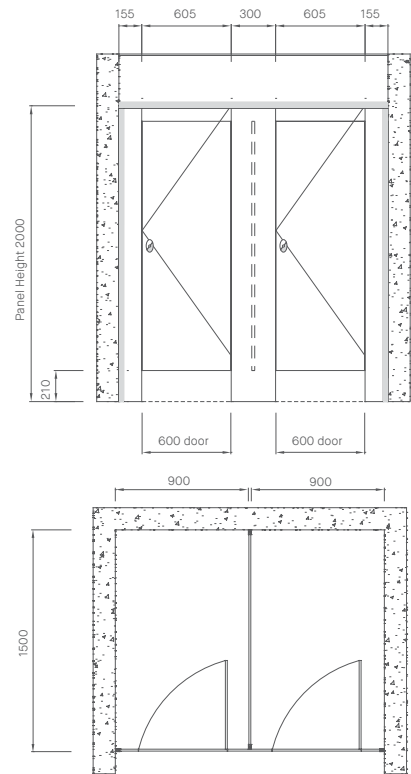

Panel Substrate	Laminex Multipurpose Compact Laminate 13mm Laminex Multipurpose Compact Laminate 18mm (MTO)
Features	Anodised aluminium headrail Design registered lock/indicator Design registered concealed hinges and coat hook Privacy Bevel as standard ensures no visibility into the cubicle when in use
Hardware	Stainless steel fixings U-shaped corner channels Snap door inserts
Delivery and installation	Flat pack with instructions and tools for your own installation
Warranty and Guarantees	Laminex Compact Laminate - 10 years Door Hardware Replacement Guarantee - 5 Years
Recommended Applications	Ideal for High Traffic and High Wear Applications such as: - Education Amenities - Retail Amenities - Public Spaces Amenities

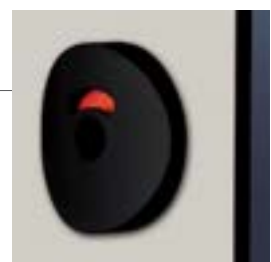

* Compact laminate is not designed for permanent immersion. Please ensure that installation conforms to the National Construction Code and water is not allowed to pool at the base of the partitioning.

Doors in **Laminex Multipurpose Compact Laminate Moose**. Panels in **Laminex Multipurpose Compact Laminate Charcoal**.

Freestanding System

A modern style system that is floor mounted on a specifically designed anodised aluminium skirt and does not require overhead bracing.

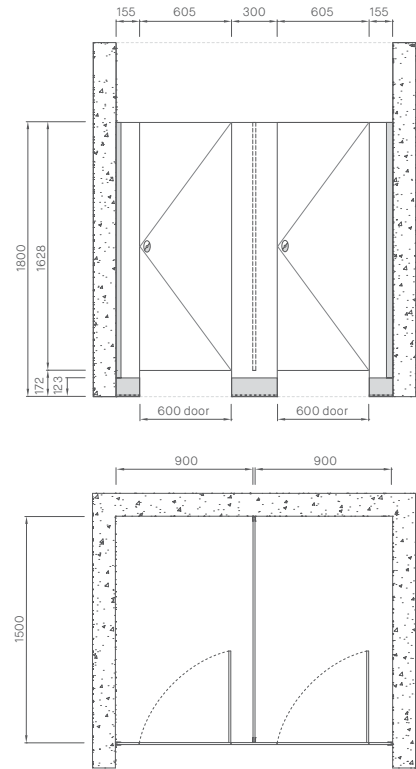

Panel Substrate	Laminex Structural MR® MDF 18mm Laminex Structural MR® MDF 32mm Laminex Multipurpose Compact Laminate 13mm Laminex Multipurpose Compact Laminate 18mm (MTO)
Features	Design registered lock/indicator Design registered concealed hinges and coat hook Design registered 'skirt' foot mounting Privacy Bevel as standard ensures no visibility into the cubicle when in use
Hardware	Stainless steel fixings U-shaped corner channel
Delivery and installation	Flat pack with instructions and tools for your own installation
Warranty and Guarantees	Laminex Structural MR® MDF - 7 years Laminex Compact Laminate - 10 years Door Hardware Replacement Guarantee - 5 Years
Recommended Applications	Ideal for Medium/High Traffic where abuse is less likely, such as: - Public Buildings - End of Trip Facilities - Office/Workspaces



Doors in Laminex Multipurpose Compact Laminate Oyster Grey. Panels in Laminex Multipurpose Compact Laminate Black.

Privacy Plus System*

A full height system, mounted floor to ceiling with a lengthened door specifically designed for additional privacy. Suitable for unisex applications.

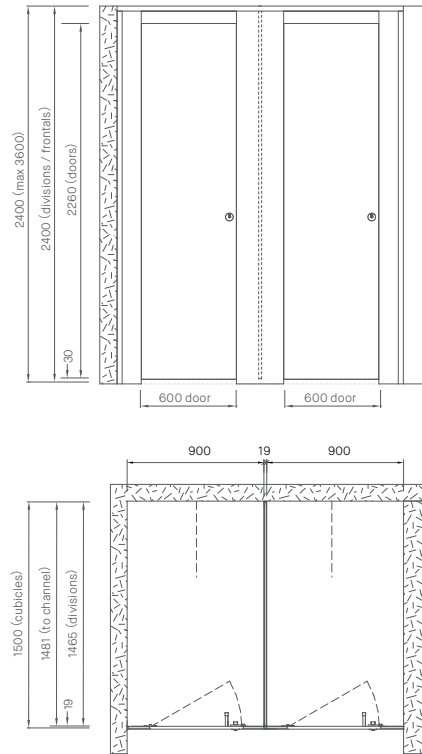

Panel Substrate	Laminex Multipurpose Compact Laminate 13mm Laminex Multipurpose Compact Laminate 18mm (MTO)
Features	Floor to ceiling divisions & front panels design Privacy Bevel as standard ensures no visibility into the cubicle when in use Design registered lock/indicator Design registered concealed hinges and coat hook
Hardware	Stainless steel fixings U-shaped corner channel
Delivery and installation	Flat pack with instructions and tools for your own installation
Warranty and Guarantees	Laminex Compact Laminate - 10 years Door Hardware Replacement Guarantee - 5 Years
Recommended Applications	Ideal for High Traffic and High Wear Applications such as: - Unisex Facilities - Education Amenities - Retail Amenities - Public Spaces Amenities - End of Trip Facilities



* Compact laminate is not designed for permanent immersion. Please ensure that installation conforms to the National Construction Code and water is not allowed to pool at the base of the partitioning.

Installation must comply to:
- AS3740-2010: Waterproofing of Domestic Wet Areas, and;
- Australian Construction Code - ACC Vol.1 & Vol. 2 - Building Code of Australia.

Doors in **Laminex Multipurpose Compact Laminate in Fossil**.
Panels in **Laminex Multipurpose Compact Laminate in Seasoned Oak**.

Beam Suspended System

A premium system that floats off the floor for a sleek look and superior clean ability.

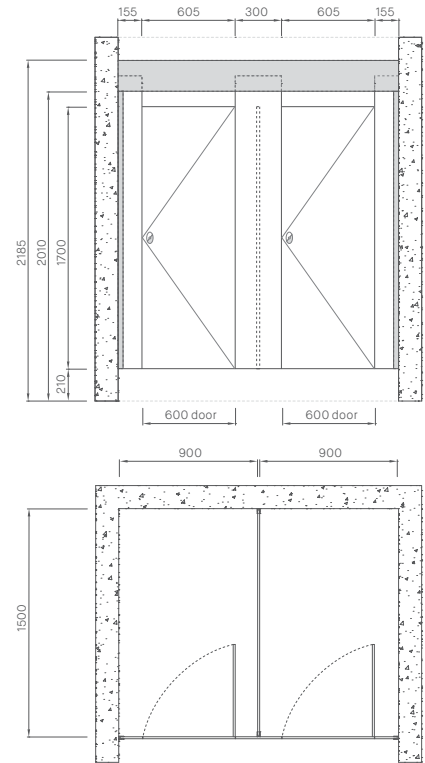

Panel Substrate	Laminex Structural MR® MDF 18mm Laminex Structural MR® MDF 32mm Laminex Multipurpose Compact Laminate 13mm Laminex Multipurpose Compact Laminate 18mm (MTO)	
Features	Stylish anodised aluminium headrail suspension beam Design registered lock/indicator Design registered concealed hinges and coat hook Privacy Bevel as standard ensures no visibility into the cubicle when in use	
Hardware	Stainless steel fixings U-shaped corner channels Snap door inserts Design registered beam	
Delivery and installation	Flat pack with instructions and tools for your own installation NB - for cubicles with a return panel or that run over four cubicles, floor support is required.	
Warranty and Guarantees	Laminex Structural MR® MDF - 7 years Laminex Compact Laminate - 10 years Door Hardware Replacement Guarantee - 5 Years	
Recommended Applications	Ideal for High Traffic and High Wear Applications such as: - Education Amenities - Retail Amenities - Public Spaces Amenities	

Doors in Laminex Multipurpose Compact Laminate in Natural Walnut and panels in Laminex Multipurpose Compact Laminate in Battalion.

Privacy & Wall Panels

Privacy screen for open bathrooms which allows for flexibility in design and alignment of decor for consistency.

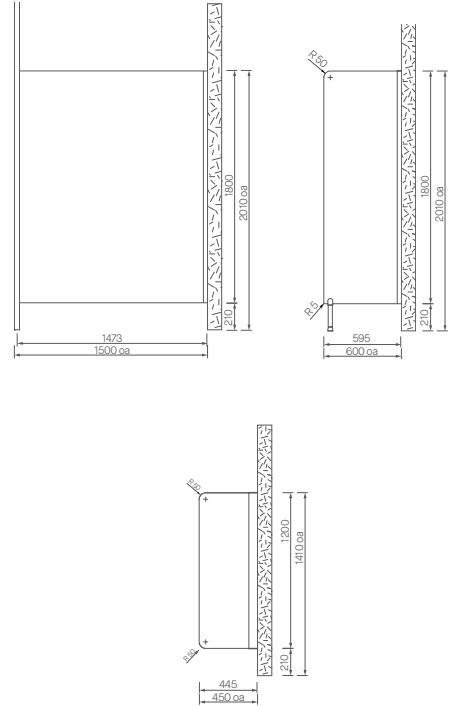

Models	Floor to ceiling
	- Entry panels & screens in high traffic areas. - Suitable for panels over 600mm wide.
	Pedestal Mounted
	- Screens in low traffic areas. - Suitable for panels up to 600mm
	Urinal Partition
	- For privacy between urinals

Panel Substrate	Laminex Structural MR® MDF 18mm for dry areas
	Laminex Structural MR® MDF 32mm for dry areas
	Laminex Multipurpose Compact Laminate 13mm for high humidity areas
	Laminex Multipurpose Compact Laminate 18mm (MTO)

Hardware	Stainless steel fixings
	Exclusive custom fixing channel - Royal Channel

Delivery and installation Delivered as a flatpack with instructions & tools for your own installation.

Warranty & Guarantees	Laminex Structural MR® MDF - 7 years
	Laminex Compact Laminate - 10 years
	Hardware - 2 Years

Privacy Panels: Laminex Multipurpose Compact Laminate in AbsoluteMatte French Navy.

Custom Systems

Whether it's alternate hardware or fixings, odd shaped or routed doors, talk to our specialist team about a custom design that suits your needs.

Kinder System

With rounded corners, and available in a variety of colours, this reduced height partition system is perfect for any childcare facility.

Panel Substrate	Laminex Multipurpose Compact Laminate 13mm for high humidity areas Laminex Multipurpose Compact Laminate 18mm (MTO)
Hardware	Stainless steel fixings U-shaped corner channels
Delivery and installation	Delivered as a flat pack with instructions and tools for your own installation
Warranty and Guarantees	Laminex Compact Laminate - 10 years Door Hardware Replacement Guarantee - 5 Years



Kinder System Laminex Spinifex and Laminex Oyster Grey.



Ceiling Suspended System with Matte Black hardware in Laminex Otway.

Ceiling Suspended System

An impression of total suspension. Suspend your partitions from within the ceiling without touching the floor beneath.

Panel Substrate	Laminex Multipurpose Compact Laminate 13mm Laminex Multipurpose Compact Laminate 18mm (MTO) Laminex Structural MR MDF 18mm or 32mm
Hardware	Stainless steel fixings U-shaped corner channels
Headrail Beam Option	Concealed above ceiling
Delivery and installation	Delivered as a flat pack with instructions and tools for your own installation
Warranty and Guarantees	Laminex Compact Laminate - 10 years Laminex Structural MR MDF - 7 years Door Hardware Replacement Guarantee - 5 Years



ABOVE: Lockers: Z-Door System in Laminex Calm Oak. 1-Door System in Laminex Terril
Seating: Island Seating in Laminex Coastal Sunrise.



Lockers

Multiple configurations and lock options available. Durable 13mm Laminex Compact Laminate end panels and doors with Decorated Particleboard or V-Lite carcass. Ventilation ensures suitability for humid areas.

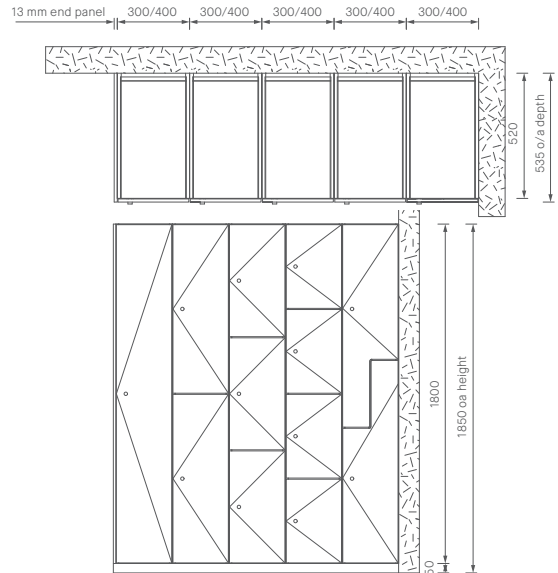

Panel Substrate	Laminex Multipurpose Compact Laminate 13mm Laminex Multipurpose Compact Laminate 18mm (MTO) Structural MR MDF 18mm White Particleboard - Locker Carcasses V-Lite foamed panels - Locker Carcasses
Features	Custom locker configurations to suit your project Door configurations available in standard 300mm or jumbo 400mm widths Standard 1800mm high and 535mm deep Available fully assembled.
Hardware	Ojmar security locks used in a wide range of functions designed specifically for wet and high humidity areas Optional heavy duty 180° fold-flat hinges available Locker ventilations inserts in all individual locker carcasses
Delivery & installation	Lockers are delivered assembled Installation experts can be referred as required
Warranty & Guarantees	Laminex Compact Laminate - 10 years Laminex Structural MR MDF - 7 years Trade Essentials Whiteboard - 7 Years Trade Essentials V-Lite PVC Panels - 7 years

Locks

Laminex Waterloo Lockers use Europe's market leader, Ojmar locks, for our wide range of lock options. Ojmar locks have an unmatched reputation as the best locks in the common wet and humid conditions of locker areas.



Lockers in Laminex Multipurpose Compact Laminate in Classic Oak with Key Lock hardware.



Lockers: **Z-Door System** with **Laminex Multipurpose Compact Laminate** in **Laminex Raw Birchply**.
Project: Darby Plaza. Designer: EJE Architects. Photography: Jim Young, Australian National Construction Review.

Vanities

Extremely durable Laminex 13mm Compact Laminate Vanities come deep, fully-recessed and semi-recessed with splash backs. Standard as well as custom options available. Excellent water resistance, offering a premium level of hygiene.

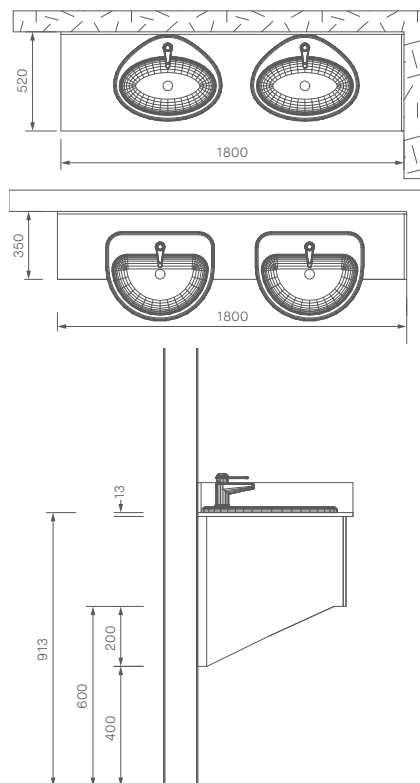

Panel Substrate	Laminex Multipurpose Compact Laminate 13mm Laminex Multipurpose Compact Laminate 18mm (MTO)
Features	Standard 520mm deep fully recessed and 350mm deep semi recessed top Choice of square or round basins Available with or without 100mm high splash back 300 mm high front fascia to conceal fittings and increase strength and structural integrity Decorative end panels Comes in a variety of colour options in the Laminex range Length customised to suit individual requirements
Hardware	All components and parts are impact resistant and non-corrosive
Delivery & installation	Flat pack with instructions and tools for your own installation Installation experts can be referred as required
Warranty & Guarantees	Laminex Compact Laminate - 10 years

Vanities in Laminex Multipurpose Compact Laminate in Battalio.



ABOVE: Vanity Unit with **Laminex Otway** and **Laminex Planked Urban Oak** in **Laminex Multipurpose Compact Laminate**.

Seating & Combination Units

Market leading dry and wet area solution, standard sizes and custom design, durable option for high traffic areas. Wall seating, island seating and custom seating available in full or slat bench seating. Optional back support and coat hook rail above.



Wall Seating



Combination Unit



Island Seating

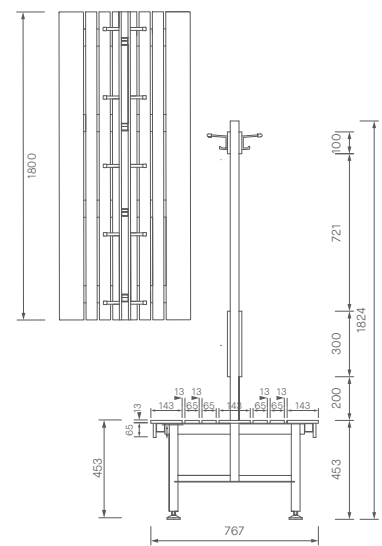
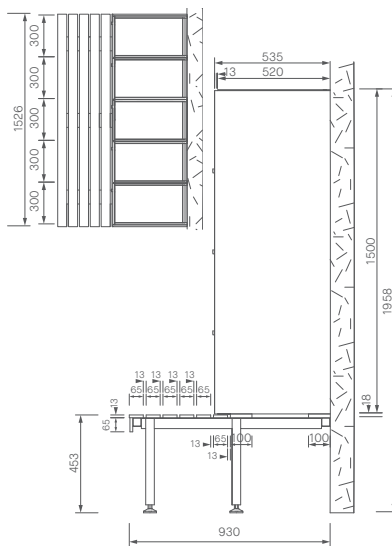
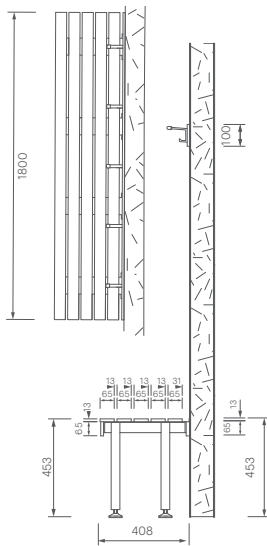

Panel Substrate

Laminex Multipurpose Compact Laminate 13mm
Laminex Multipurpose Compact Laminate 18mm (MTO)

Features

Fully hose-able seating with rust-free and adjustable aluminium legs (also available in powder coating)
Available in standard lengths of 900mm, 1600mm, 2300mm and 3000mm
Available in slats seat tops as the standard with other styles upon request i.e. full panel seat top or grooved slats seats

Wall Seating

Standard 460mm high x 410mm wide
Optional coat hook rail

Island Seating

Standard 460mm high x 770mm wide
Standard double sided back support (or optional without)

Delivery & installation

Delivered Assembled
Installation experts can be referred as required

Warranty & Guarantees

Laminex Compact Laminate - 10 years

Island & Wall Seating in **Laminex Multipurpose Compact Laminate in Raw Birchply**.
Combination Unit in **Laminex Multipurpose Compact Laminate in Charcoal, Oyster Grey & Raw Birchply**.



ABOVE: Lockers: **1-Door System** in **Laminex Terril**
Seating: **Island Seating** in **Laminex Coastal Sunrise**.

Step 02

Choose Your Substrate



Lockers: **Laminex Multipurpose Compact Laminate in Raw Birchply**
Project: Darby Plaza. Designer: EJE Architects.
Photography: Jim Young, Australian National Construction Review.

Materials Substrate

Wet or dry areas - our products stand up in any environment.

All substrates are proudly made in Australia.

WET & DRY AREAS

Laminex Multipurpose Compact Laminate 13mm

- Self-supporting high pressure laminate based on thermosetting resins homogeneously reinforced with cellulose fibres.
- High pressure decorative laminate applied to both sides.
- All cut edges have a polished black edge that doesn't require additional laminate for added protection.
- Excellent resistance to scratches, graffiti, vandalism and water.
- Premium level of hygiene protection in healthcare environments.
- Limited colours also available in 18mm, refer to Availability Guide.
- All Laminex Multipurpose Compact Laminate comes with Protec+ Antimicrobial Technology, making it the safer choice.
- Global GreenTag Certified - Level A.



Made in Australia



Protec+ Antimicrobial Technology

DRY AREAS ONLY

Laminex Structural MR[®] MDF 18mm/32mm

- A robust MDF core that provides superior impact resistance. The 18mm substrate features an extra high density core for up to twice the impact resistance of Laminex Vertiboard 18mm.
- Decorative melamine surface pressed on both sides of the board.
- All Laminex Structural MR MDF comes with Protec+ Antimicrobial Technology, making it the safer choice.
- Global GreenTag Certified- Level A.



Made in Australia



Protec+ Antimicrobial Technology

Step 03

Choose Your Colours

Scan here
to order
samples



Legend

WET & DRY AREAS

MC Laminex Multipurpose Compact Laminate

DRY AREAS ONLY

ST Laminex Structural MR® MDF

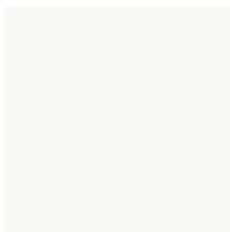

Polar White
MC ST

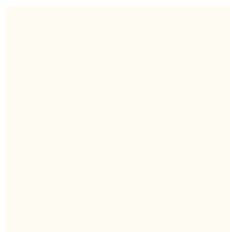

White
MC ST



Parchment
MC

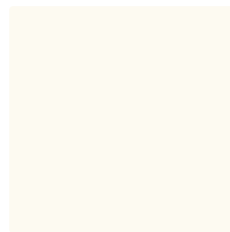

Ghostgum
MC ST

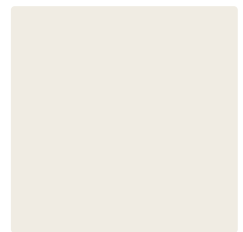

Aries
MC

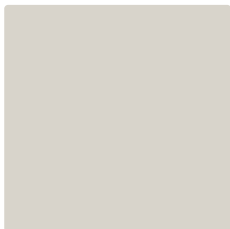

Oyster Grey
MC ST

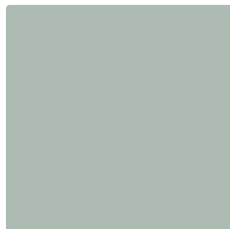

Spinifex
MC ST

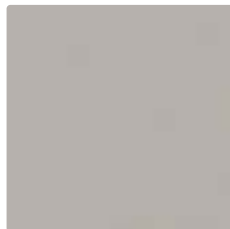

Fox
MC



Tornado
MC



Lava Grey
MC

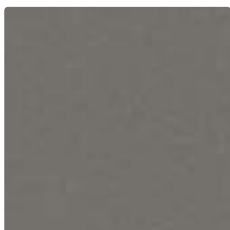

Moose
MC



Olivine^
MC ST

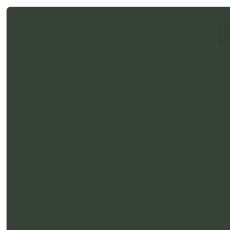

Otway
MC ST

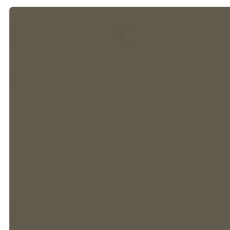

Fossil
MC

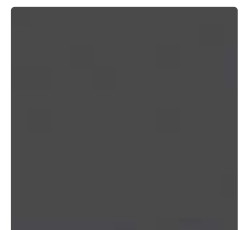

Battalion
MC

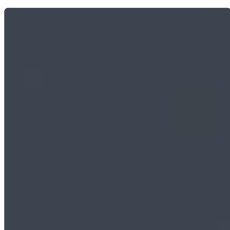

Charcoal
MC

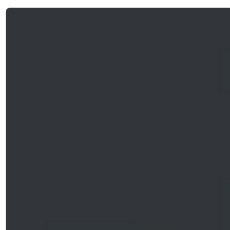

Terril
MC ST



French Navy
MC ST



Black
MC ST



Seasoned Oak
MC



Oyster Linea
MC



Raw Birchply
MC ST

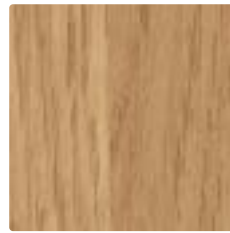

Elegant Oak
MC ST

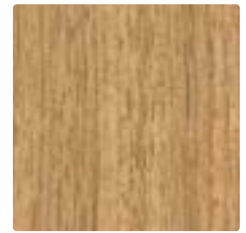

Sublime Teak
MC ST



Classic Oak
MC ST

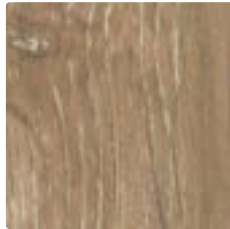

Rural Oak
MC

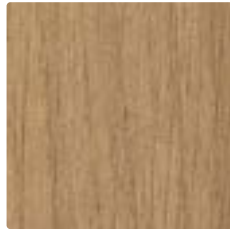

Planked Urban Oak
MC

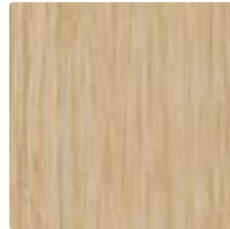

Calm Oak#
MC

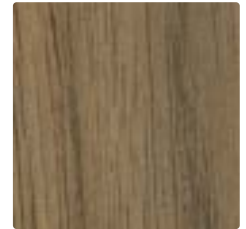

Natural Walnut
MC

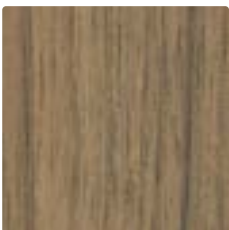

Danish Walnut
MC ST

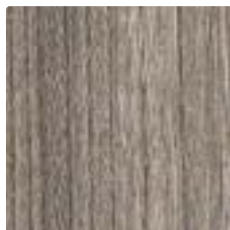

Lustrous Elm
MC



Zincworks
MC

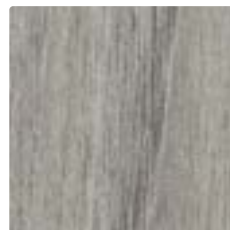

Fox Teakwood
MC

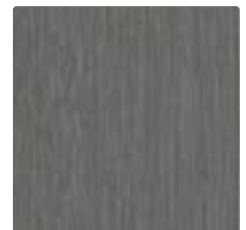

New Graphite
MC



Greystone
MC

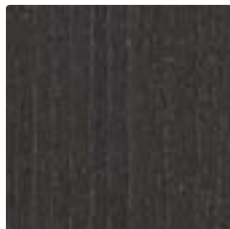

Burnished Wood
MC ST



Manhattan Concrete
MC



Portsea^
MC ST



Moroccan Clay
MC ST

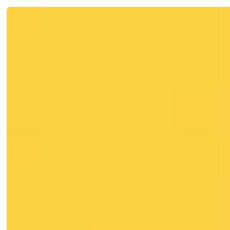

Golden Wattle^
MC

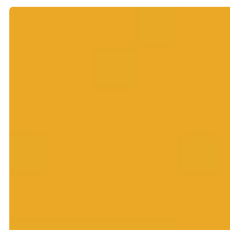

Coastal Sunrise^
MC



Pillarbox^
MC

Introducing to Multipurpose Range Laminex TrueScale™

Laminex TrueScale is a celebration of scale and stone. In a market first, slabs of immense size have been reproduced and printed without repeat, down to the smallest detail.



Calacatta Majore TrueScale™
MC



Premio Carrara TrueScale™
MC



Luxe Elba TrueScale™
MC



Marmo Grigio TrueScale™
MC

Scan here to
view full sheets
and learn more.



Multipurpose Compact Laminate AbsoluteMatte® Finish

Available now in Laminex Compact Laminate, AbsoluteMatte is a super-matte, intriguingly tactile and fingerprint-resistant surface. With the combination of InvisiTouch™ Technology, Protec+ Technology and Compact Laminate features, Laminex AbsoluteMatte® Multipurpose Compact Laminate is an extremely durable, hygienic, world-leading surface that stays looking smarter and cleaner for longer.

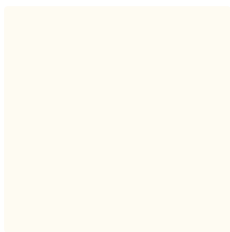

White

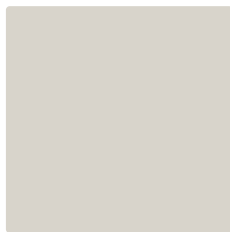

Oyster Grey

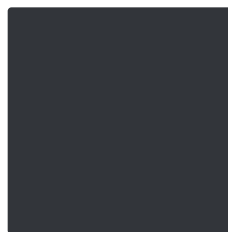

Terril



Black

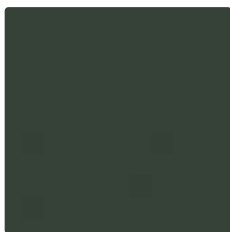

Otway



French Navy

Note: Other AbsoluteMatte decors are available MTO for larger projects. Minimum Order Quantities apply.

Laminex AbsoluteMatte Compact Laminate Features



Horizontal Application



Vertical Application



Fingerprint Resistant



Antimicrobial



Stain Resistant



Heat Resistant



Water Resistant



Scratch Resistant



UV Stable Indoor Use



Made in Australia



Protec+ Antimicrobial Technology

Availability Guide

Waterloo Partitioning Systems are available in all Laminex Multipurpose Compact and Laminex Structural MR MDF colour and finish options, giving you the choice of over 50 stunning décor options. Refer to the availability guide below for a complete list of Colour & Finish options for each substrate.

TYPE	APPLICATION		WET & DRY AREAS					DRY AREAS ONLY					
	PRODUCT		MULTIPURPOSE COMPACT LAMINATE					STRUCTURAL MR MDF					
	THICKNESS (MM)		13MM			18MM		18MM			32MM		
	FINISH		NATURAL	CHALK	NUANCE	ABSOLUTE MATTE™	NATURAL	NATURAL	FLINT	CHALK	NUANCE	NATURAL	
	COLOUR DESCRIPTION	CODE											
WHITES & NEUTRALS	Aries	079	✓										
	Battalion	042	✓				✓						
	Black	460	✓		✓	✓			✓				
	Charcoal	461	✓										
	Fossil	463	✓										
	Fox	080	✓				✓						
	French Navy	8541	✓			✓		✓					
	Ghostgum	086	✓					✓					
	Lava Grey	8538	✓										
	Olivine	161	✓					✓					
	Otway	1035	✓			✓			✓				
	Oyster Grey	327	✓			✓		✓					
	Parchment	202	✓										
	Polar White	205	✓					✓					
	Spinifex	8539	✓					✓					
	Terril	2297	✓			✓			✓				
	Tornado	081	✓										
	White	200	✓		✓	✓	✓	✓				✓	
	WOODS	Burnished Wood	602	✓		✓			✓				
		Calm Oak		✓									
Classic Oak		8537	✓		✓		✓	✓			✓		
Danish Walnut		643	✓					✓					
Elegant Oak		078	✓	✓				✓		✓			
Fox Teakwood		8907	✓										
Lustrous Elm		274	✓		✓								
Natural Walnut		068	✓										
Oyster Linea		289	✓										
Planked Urban Oak		9312	✓										
Raw Birchply		8910	✓	✓				✓					
Rural Oak		077	✓										
Seasoned Oak		458	✓	✓									
Sublime Teak		288	✓	✓				✓		✓			
ACCENTS		Coastal Sunrise	1034	✓									
	Golden Wattle	1033	✓										
	Moroccan Clay	150	✓						✓				
	Moose	134	✓										
	New Graphite	486	✓										
	Pillarbox	438	✓										
	Portsea	1031	✓					✓					
	Zincworks	869	✓										
MINERALS	Calacatta Majore TrueScale	3001	✓										
	Luxe Elba TrueScale	3003	✓										
	Manhattan Concrete	637	✓										
	Marmio Grigio TrueScale	3005	✓										
	Premio Carrara TrueScale	3002	✓										
Greystone	772	✓											

Specifying Laminex Waterloo

Laminex Waterloo Partitioning Systems have been tested and fully comply with:

- Clause 6.2 of the Australian Standard AS1428.1:2009 Design for Access and Mobility Part 1:
- General requirements for access, detailing minimum:
- Width requirements (900 & 920mm internal)
- Height below head rail (2000mm above finish floor level)
- Door gap spacings (>700mm)
- Space inside cubicles (900mm clear space in front of toilet pan)
- Disabled requirements









ABOVE: Floor to Ceiling Partitioning System in **Laminex Multipurpose Compact Laminate** in **Classic Oak**.
Project: Pinnacle One Gym. Architect/Designer: InOne Projects. Photographer: Martin Seigner (FRMEZ).

Specification Guide

Please use the following table to specify Laminex Waterloo Partitioning Systems:

Item	Description	Supplier	Comments	Image
Toilet Partitioning – Pedestal Mounted	<p>System: Pedestal Mounted System Code: TP01 Hardware & Channels: Anodised Aluminium/ Matte Black Material: [Insert Substrate & Thickness Here] Colour: Doors – [Insert Colour Here] Panels – [Insert Colour Here] Finish: [Insert Finish Here]</p>	Laminex Waterloo Partitions Contact: partitioning@laminex.com.au 132 136 (option 5)	Installation in accordance with manufacturer's recommendations. Ambulant cubicle's to be installed to comply with AS1428.1-2009	
Toilet Partitioning – Floor Mounted	<p>System: Floor Mounted System Code: TP02 Hardware & Channels: Anodised Aluminium/ Matte Black Material: [Insert Substrate & Thickness Here] Colour: Doors – [Insert Colour Here] Panels – [Insert Colour Here] Finish: [Insert Finish Here]</p>	Laminex Waterloo Partitions Contact: partitioning@laminex.com.au 132 136 (option 5)	Installation in accordance with manufacturer's recommendations. Ambulant cubicle's to be installed to comply with AS1428.1-2009	
Toilet Partitioning – Floor to Ceiling	<p>System: Floor to Ceiling System Code: TP03 Hardware & Channels: Anodised Aluminium/ Matte Black Material: [Insert Substrate & Thickness Here] Door Shape: [Arched or Square] Colour: Doors – [Insert Colour Here] Panels – [Insert Colour Here] Finish: [Insert Finish Here]</p>	Laminex Waterloo Partitions Contact: partitioning@laminex.com.au 132 136 (option 5)	Installation in accordance with manufacturer's recommendations. Ambulant cubicle's to be installed to comply with AS1428.1-2009	
Toilet Partitioning – Freestanding	<p>System: Freestanding System Code: TP04 Hardware & Channels: Anodised Aluminium/ Matte Black Material: [Insert Substrate & Thickness Here] Colour: Doors – [Insert Colour Here] Panels – [Insert Colour Here] Finish: [Insert Finish Here]</p>	Laminex Waterloo Partitions Contact: partitioning@laminex.com.au 132 136 (option 5)	Installation in accordance with manufacturer's recommendations. Ambulant cubicle's to be installed to comply with AS1428.1-2009	
Toilet Partitioning – Privacy Plus	<p>System: Privacy Plus System Code: TP05 Hardware & Channels: Anodised Aluminium/ Matte Black Material: [Insert Substrate & Thickness Here] Colour: Doors – [Insert Colour Here] Panels – [Insert Colour Here] Finish: [Insert Finish Here]</p>	Laminex Waterloo Partitions Contact: partitioning@laminex.com.au 132 136 (option 5)	Installation in accordance with manufacturer's recommendations. Ambulant cubicle's to be installed to comply with AS1428.1-2009	
Toilet Partitioning – Beam Suspended	<p>System: Beam Suspended System Code: TP06 Hardware & Channels: Anodised Aluminium/ Matte Black Material: [Insert Substrate & Thickness Here] Colour: Doors – [Insert Colour Here] Panels – [Insert Colour Here] Finish: [Insert Finish Here]</p>	Laminex Waterloo Partitions Contact: partitioning@laminex.com.au 132 136 (option 5)	Installation in accordance with manufacturer's recommendations. Ambulant cubicle's to be installed to comply with AS1428.1-2009	
Toilet Partitioning – Custom System	<p>System: Custom System Code: TP07 Hardware & Channels: Anodised Aluminium/ Matte Black Material: [Insert Substrate & Thickness Here] Colour: Doors – [Insert Colour Here] Panels – [Insert Colour Here] Finish: [Insert Finish Here]</p>	Laminex Waterloo Partitions Contact: partitioning@laminex.com.au 132 136 (option 5)	Installation in accordance with manufacturer's recommendations. Ambulant cubicle's to be installed to comply with AS1428.1-2009	

Item	Description	Supplier	Comments	Image
Lockers	<p>System: [1,2,3,4,Z]-Door Locker System Code: L001 Hardware & Channels: [Insert Lock System Here.] Material: Doors- 13mm Compact Carcase material – V-Light Colour: [Insert Colour Here] Finish: [Insert Finish Here]</p>	<p>Laminex Waterloo Partitions Contact: partitioning@laminex.com.au 132 136 (option 5)</p>	<p>All joinery locks to be keyed to client's specifications. Allow for coordination with client onsite.</p>	
Island Seating	<p>System: Island Bench Seating Code: IS01 Hardware & Channels: Anodised Aluminium/ Matte Black Material: 13mm Laminex Multipurpose Compact Laminate Colour: [Insert Colour Here] Finish: [Insert Finish Here]</p>	<p>Laminex Waterloo Partitions Contact: partitioning@laminex.com.au 132 136 (option 5)</p>	<p>Install as per manufacturer's specifications / recommendations</p>	
Wall Seating with Coat Hook Rail	<p>System: Wall Bench Seating w/ Coat Hook Rail Code: WS01 Hardware & Channels: Anodised Aluminium/ Matte Black Material: 13mm Laminex Multipurpose Compact Laminate Colour: [Insert Colour Here] Finish: [Insert Finish Here]</p>	<p>Laminex Waterloo Partitions Contact: partitioning@laminex.com.au 132 136 (option 5)</p>	<p>Install as per manufacturer's specifications / recommendations</p>	
Combination Unit	<p>System: Combination Unit Code: CU01 Hardware & Channels: [Insert Lock System Here] Anodised Aluminium/Matte Black Legs Material: 13mm Laminex Multipurpose Compact Laminate Colour: [Insert Colours Here] Finish: [Insert Finish Here]</p>	<p>Laminex Waterloo Partitions Contact: partitioning@laminex.com.au 132 136 (option 5)</p>	<p>Install as per manufacturer's specifications / recommendations</p>	
Privacy Panel	<p>System: Privacy Panel Code: PP01 Hardware & Channels: Anodised Aluminium/ Matte Black Material: 13mm Laminex Multipurpose Compact Laminate Colour: [Insert Colour Here] Finish: [Insert Finish Here]</p>	<p>Laminex Waterloo Partitions Contact: partitioning@laminex.com.au 132 136 (option 5)</p>	<p>Install as per manufacturer's specifications / recommendations</p>	
Vanity – Fully-Recessed	<p>System: Fully-Recessed Vanity Code: VA01 Hardware & Channels: Anodised Aluminium/ Matte Black Material: 13mm Laminex Multipurpose Compact Laminate Colour: [Insert Colour Here] Finish: [Insert Finish Here]</p>	<p>Laminex Waterloo Partitions Contact: partitioning@laminex.com.au 132 136 (option 5)</p>	<p>Install as per manufacturer's specifications / recommendations</p>	
Vanity – Semi-Recessed	<p>System: Semi-Recessed Vanity Code: VA02 Hardware & Channels: Anodised Aluminium/ Matte Black Material: 13mm Laminex Multipurpose Compact Laminate Colour: [Insert Colour Here] Finish: [Insert Finish Here]</p>	<p>Laminex Waterloo Partitions Contact: partitioning@laminex.com.au 132 136 (option 5)</p>	<p>Install as per manufacturer's specifications / recommendations</p>	

Visit Us

For technical information
visit laminex.com.au

Contact Us

For all Waterloo enquiries
call 132 136 (option 5)
or email us at
partitioning@laminex.com.au

Product Sample

For a sample visit Laminex.com.au

Follow Us

 facebook.com/Laminexau

 au.pinterest.com/Laminexau

 instagram.com/Laminexau

 youtube.com/Laminexau

Laminex Waterloo Partitioning is manufactured, marketed and distributed by Laminex Group Pty Limited ABN 98 004 093 092, trading as Laminex. The colours and finishes for all imagery and product swatches in this brochure may vary due to paper, printing processes and photographic lighting. For an accurate representation of the product, please view a physical sample. Please obtain a copy of the terms and conditions of the applicable warranties from laminex.com.au. All warranties are in addition to any rights that may exist under the Australian Consumer Law. Laminex, Waterloo.

The content of this document is intended as a guide only and its use in any respect is strictly at your own risk. While Laminex has taken all reasonable care in producing this document, Laminex makes no representations or warranties, express or implied, as to the accuracy, reliability or completeness of the information. We recommend that you seek independent advice to determine the suitability of any product or information for your intended application. To the extent permitted by law, Laminex disclaims all liability (including liability for negligence) for all loss, damage, liability or claim resulting from the use of the information provided in this document. Liability which cannot legally be excluded is limited to the maximum extent possible.

Copyright in this document is owned by Laminex Group Pty Limited (Laminex). All rights reserved. You must not use, copy, disclose or distribute the content of this document without Laminex' prior written permission.

Copyright © 2023, Laminex Group Pty Limited

LAM6913 | LNX0134 | 06/23

Laminex[®]

Protec[®] | Antimicrobial
Technology